

**ENERGIZER L92**  
Ultimate Lithium



**Specifications**

**AAA**

<b>Classification:</b>	"Cylindrical Lithium"
<b>Chemical System:</b>	Lithium/Iron Disulfide (Li/FeS <sub>2</sub> )
<b>Designation:</b>	ANSI 24-LF, IEC-FR03
<b>Nominal Voltage:</b>	1.5 Volts
<b>Storage Temp:</b>	-40°C to 60°C (-40°F to 140°F)
<b>Operating Temp:</b>	-40°C to 60°C (-40°F to 140°F)
<b>Typical Weight:</b>	7.6 grams (0.3 oz.)
<b>Typical Volume:</b>	3.8 cubic centimeters (0.2 cubic inch)
<b>Max Discharge:</b>	1.5 Amps Continuous
(single battery only)	2.0 Amps Pulse (2 sec on / 8 sec off)
<b>Max Rev Current:</b>	2 uA
<b>Typical Li Content:</b>	Less than 1 gram
<b>Typical IR:</b>	140 to 180 milliohms (depending on method)
<b>Shelf Life:</b>	15 years at 21°C
<b>Transportation:</b>	For complete details, please reference:
Global (except US):	Special Provision A45 of the International Air Transport Association Dangerous Goods Regulations
United States:	49 CFR 173.185

**Industry Standard Dimensions**

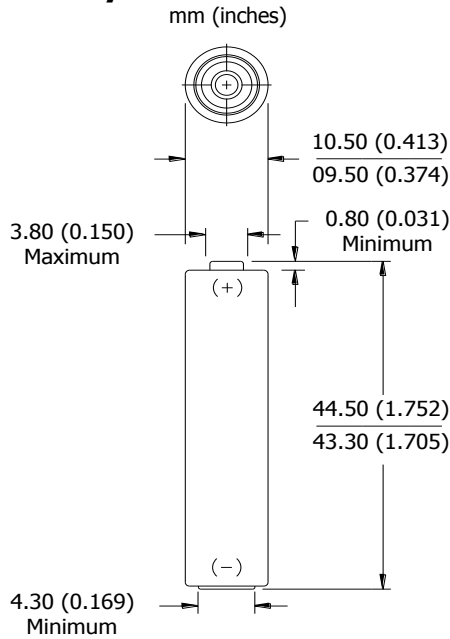

This battery has Underwriters Laboratories component recognition (MH29980)

**Milliamp-Hours Capacity**

Constant Current Discharge to 0.9 Volts at 21°C

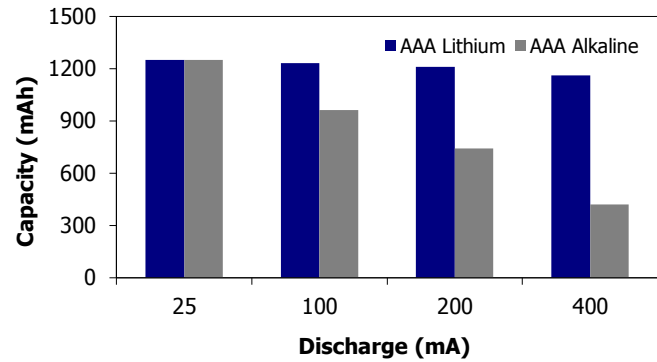

**Milliwatt-Hours Capacity at Cold/Room Temperature**

Constant Power Discharge to 1.0 Volts at 0°C and 21°C

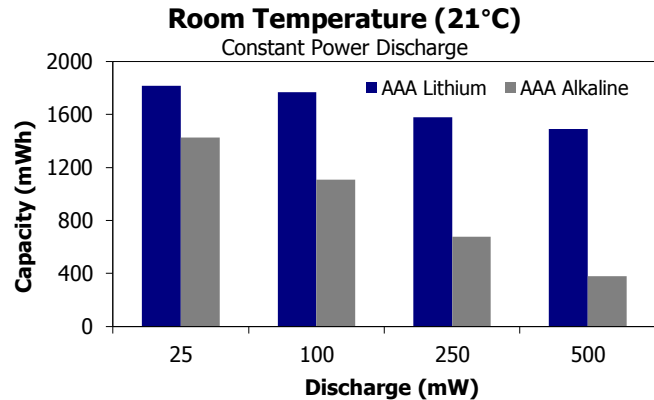
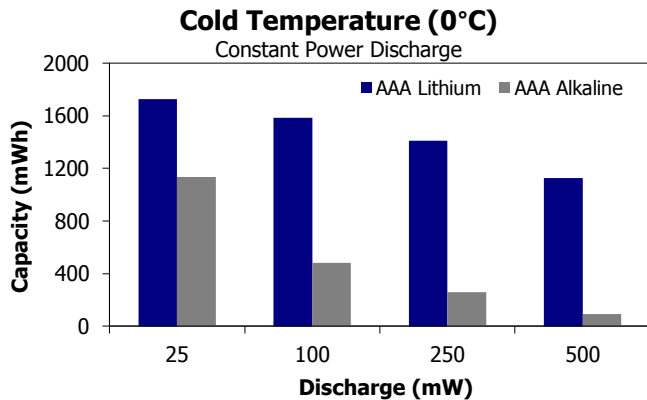

**Important Notice**

This datasheet contains typical information specific to products manufactured at the time of its publication.  
©Energizer Holdings, Inc. - Contents herein do not constitute a warranty.

# ENERGIZER L92

**AAA**

## Typical Discharge Curve Characteristics

Constant Current Discharge at 21°C (low and high drains)

### Low Drain Performance

50mA Continuous (21°C)

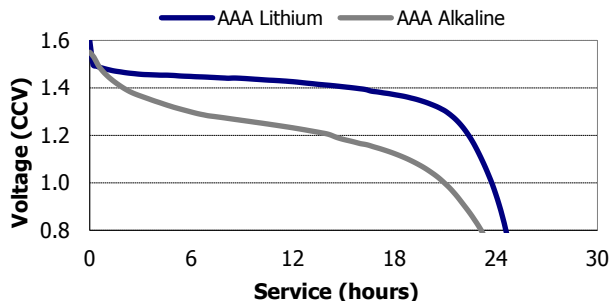

### High Drain Performance

600mA Continuous (21°C)

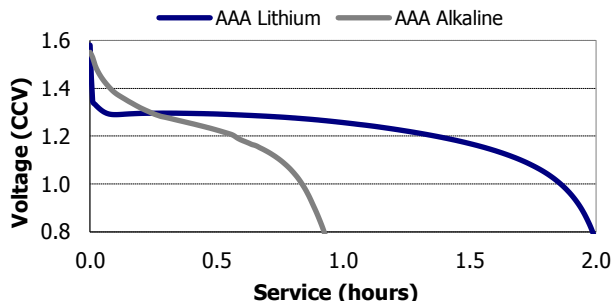

## Constant Power Performance

Typical Characteristics to 1.0 Volts (21°C)

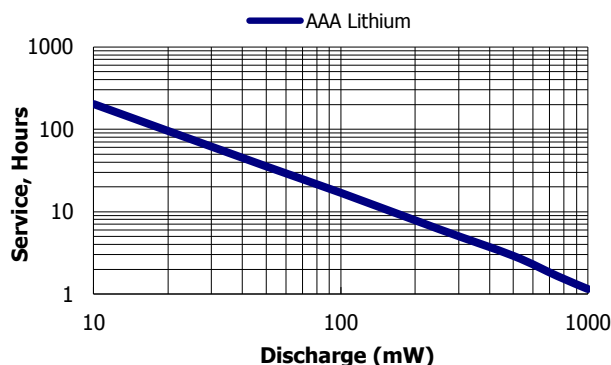

## Constant Current Performance

Typical Characteristics to 1.0 Volts (21°C)

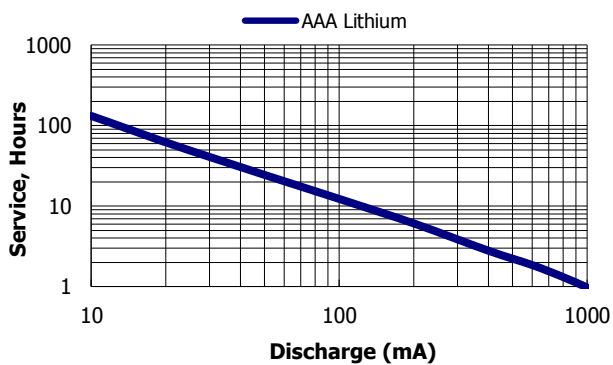

## Application Tests (21°C)

**ELECTRONIC GAME / DIGITAL AUDIO**  
100 mA 1 hr/day

**REMOTE**  
24 ohm 15 sec/min 8 hrs/day

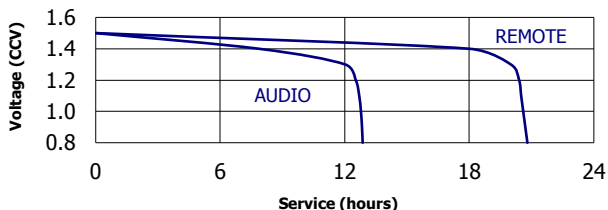

## Industry Standard Tests (21°C)

**DIGITAL STILL CAMERA (DSC)**  
.9W/.4W 2/28 sec 10x per hour

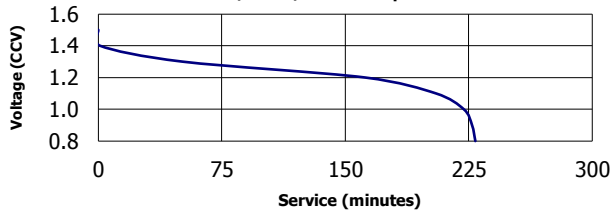

**PHOTOFLASH**  
600 mA 10 sec/min 1 hr/day

**PORTABLE LIGHTING**  
5.1 ohm LIF

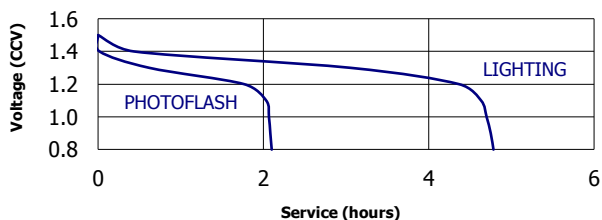

**DIGITAL STILL CAMERA (DSC)**  
1.2/.65 mW 2/.1/27.9 sec 10x per hour

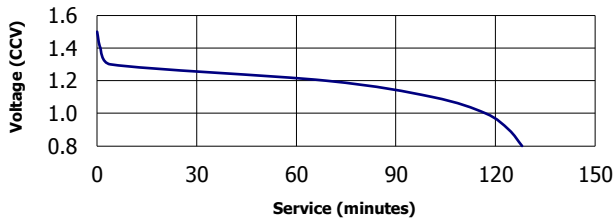

### Important Notice

This datasheet contains typical information specific to products manufactured at the time of its publication.

©Energizer Holdings, Inc. - Contents herein do not constitute a warranty.