

DESIGN MOBILE EASEL

INSTRUCTIONS • INSTRUCTIES • ISTRUZIONI • ANLEITUNG • INSTRUCCIONES • INSTRUÇÕES

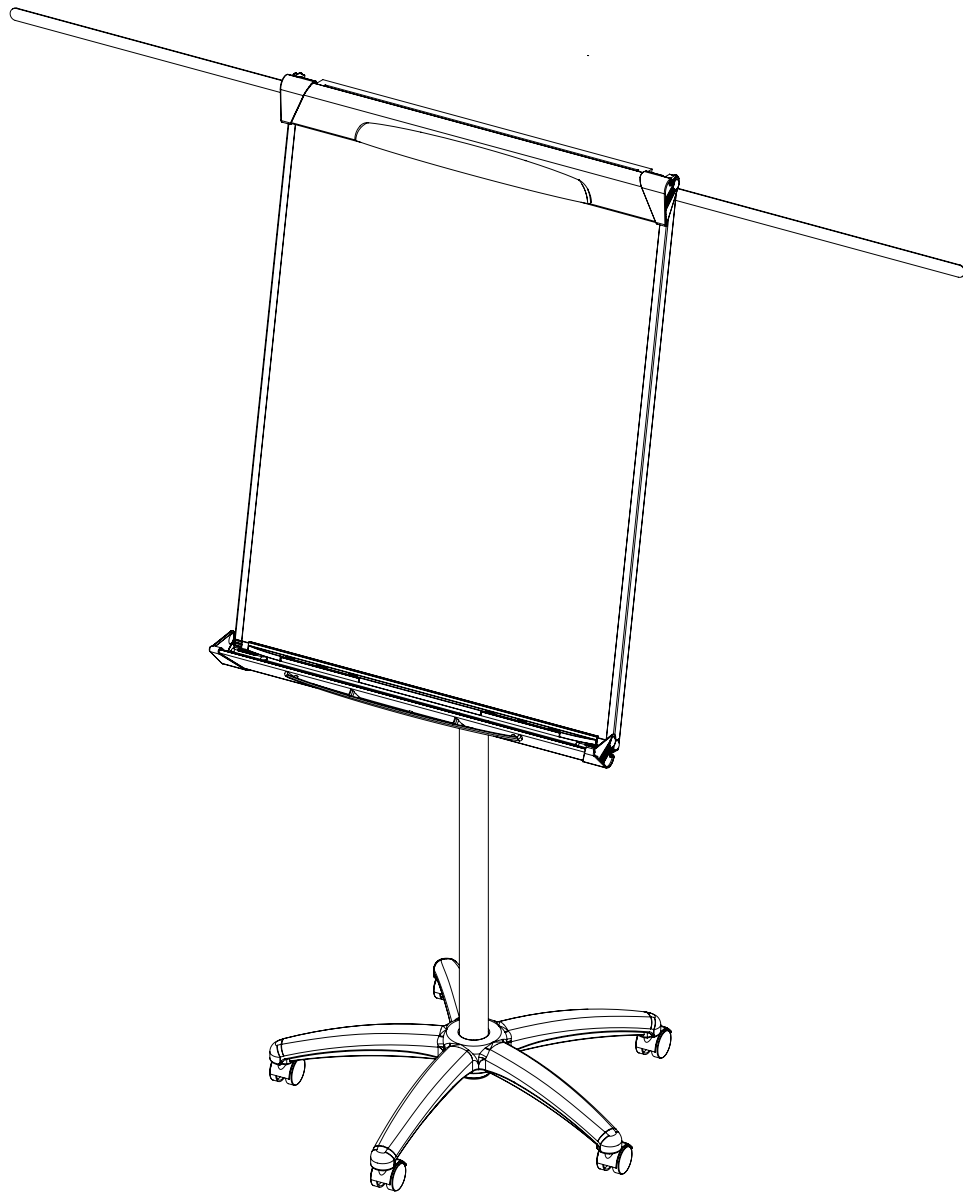

DESIGN MOBILE EASEL

INSTRUCTIONS • INSTRUCTIES • ISTRUZIONI • ANLEITUNG • INSTRUCCIONES • INSTRUÇÕES

NOT INCLUDED

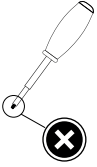

A.1x 	B.2x 	C.2x 	D.4x 	E.2x 	F.1x
WITH EXTENDABLE ARMS					
G.1x 	H.4x 	I.1x 	J.1x 	K.2x 	L.1x
M.1x 	N.1x 	O.5x 	P.1x 	Q.1x 	R.1x



DESIGN MOBILE EASEL

INSTRUCTIONS • INSTRUCTIES • ISTRUZIONI • ANLEITUNG • INSTRUCCIONES • INSTRUÇÕES



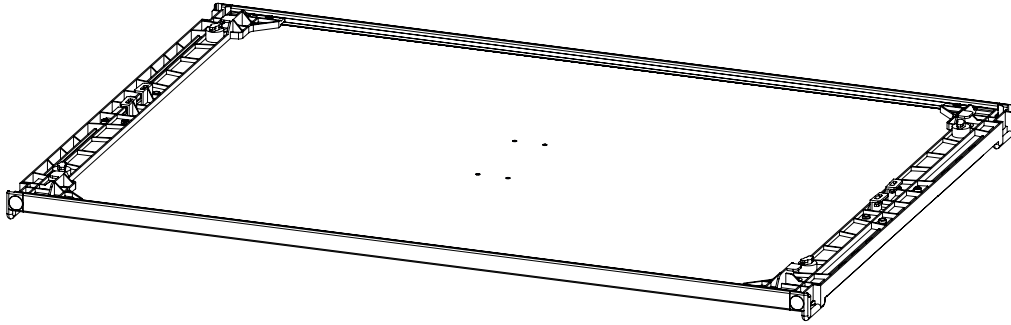





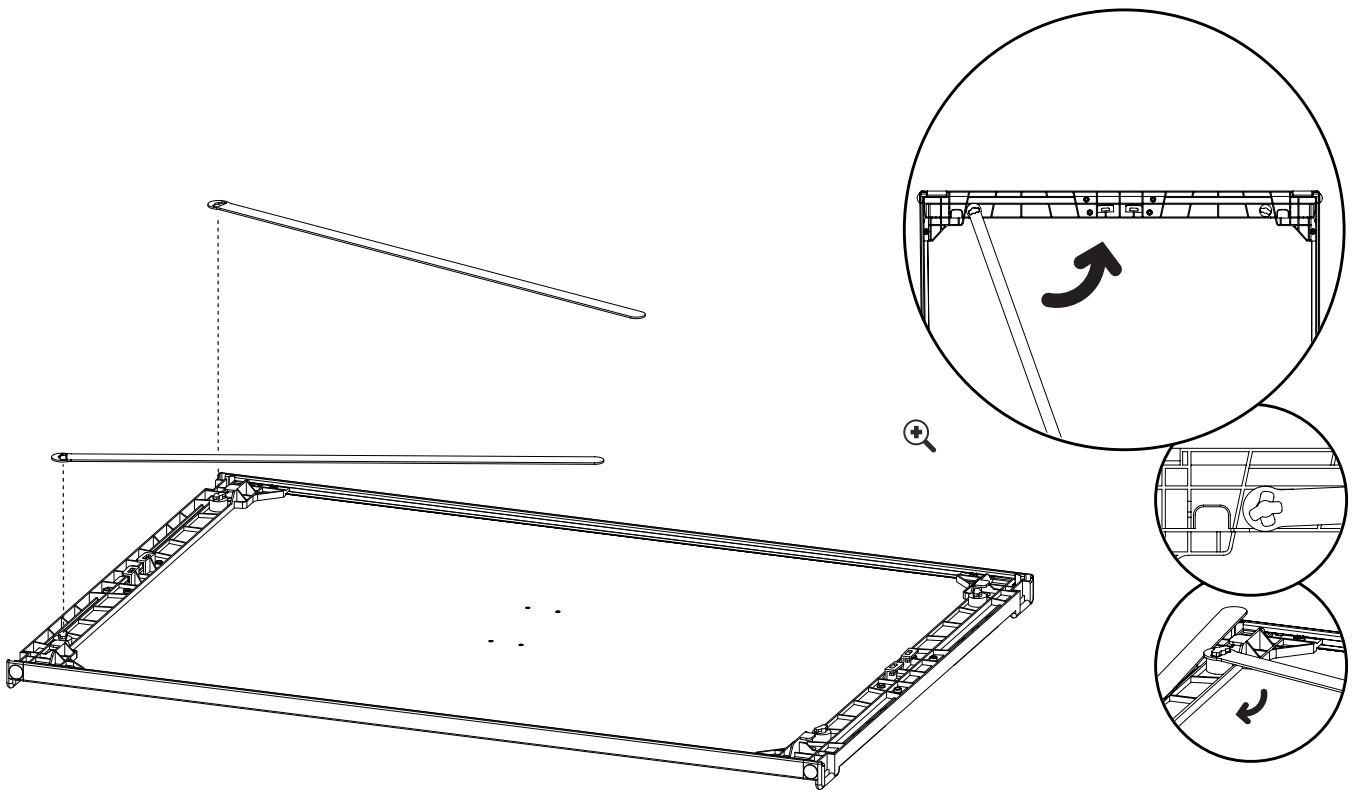

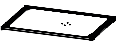







1
1.A.



WITH EXTENSIBLE ARMS

2
2.B.



- | | | | | | | | | | | |
|---|--|--|--|--|--|--|--|--|--|--|
| A.1x
 | B.2x
WITH EXTENSIBLE ARMS
 | C.2x
 | D.4x
 | E.2x
 | F.1x
 | G.1x
 | H.4x
 | I.1x
 | J.1x
 | |
| K.2x
 | L.1x
 | M.1x
 | N.1x
 | O.5x
 | P.1x
 | Q.1x
 | R.1x
 | | | |

1001380290789_REV03



DESIGN MOBILE EASEL

INSTRUCTIONS • INSTRUCTIES • ISTRUZIONI • ANLEITUNG • INSTRUCCIONES • INSTRUÇÕES

3

2.C.

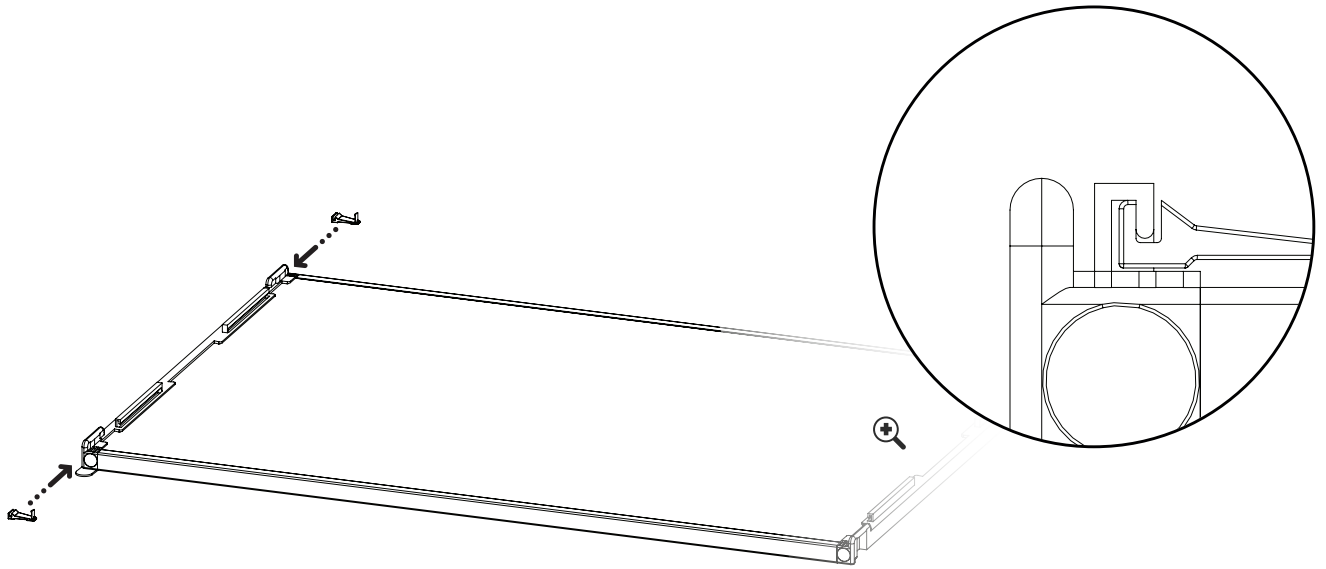

4

2.D.

1.E.

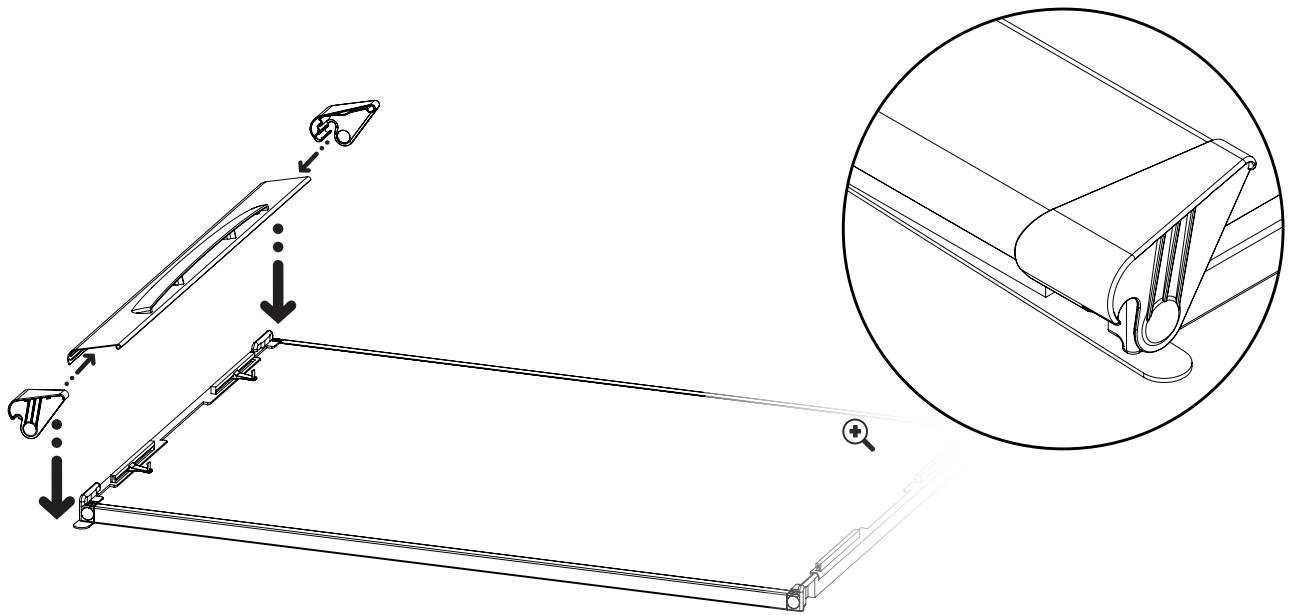

A.1x

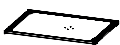

B.2x

WITH EXTENSIBLE ARMS



C.2x



D.4x



E.2x



F.1x



G.1x



H.4x



I.1x



J.1x



K.2x



L.1x



M.1x



N.1x



O.5x



P.1x



Q.1x



R.1x



1001380290789_REV03



DESIGN MOBILE EASEL

INSTRUCTIONS • INSTRUCTIES • ISTRUZIONI • ANLEITUNG • INSTRUCCIONES • INSTRUÇÕES

5



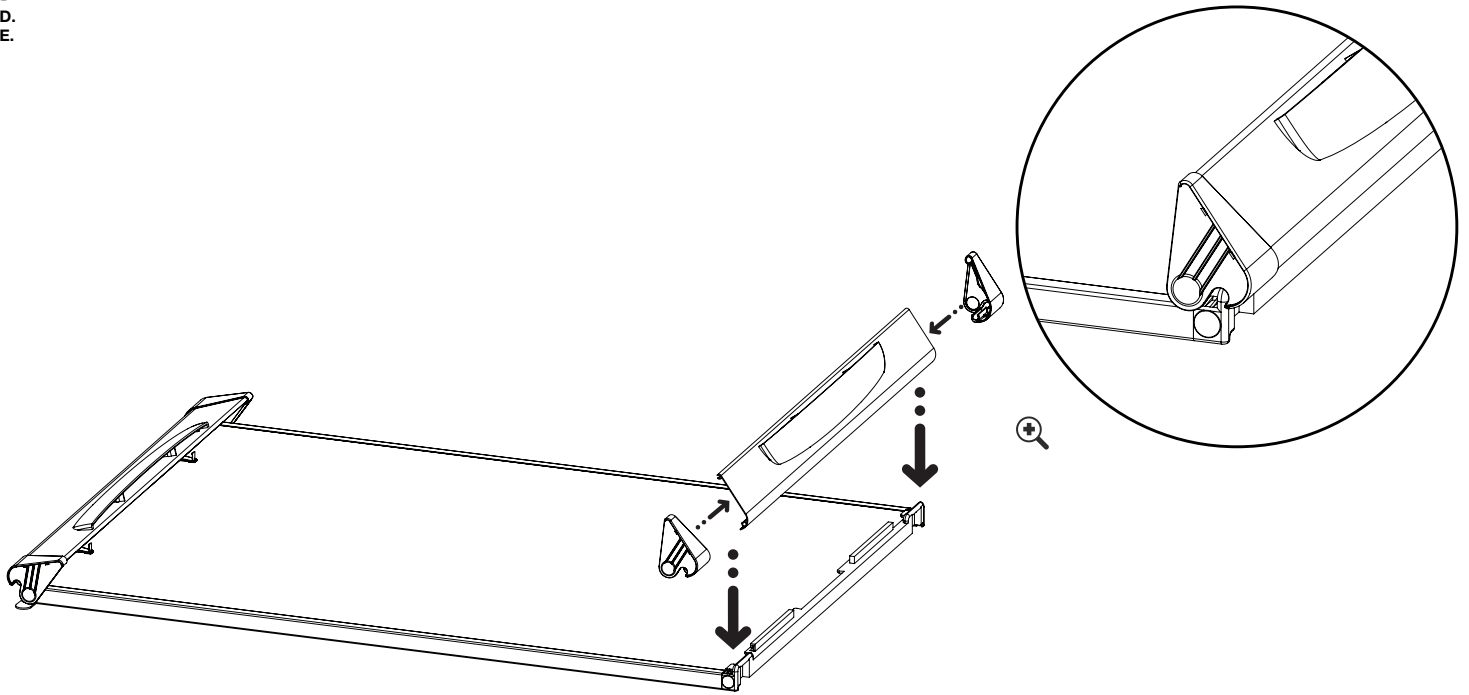





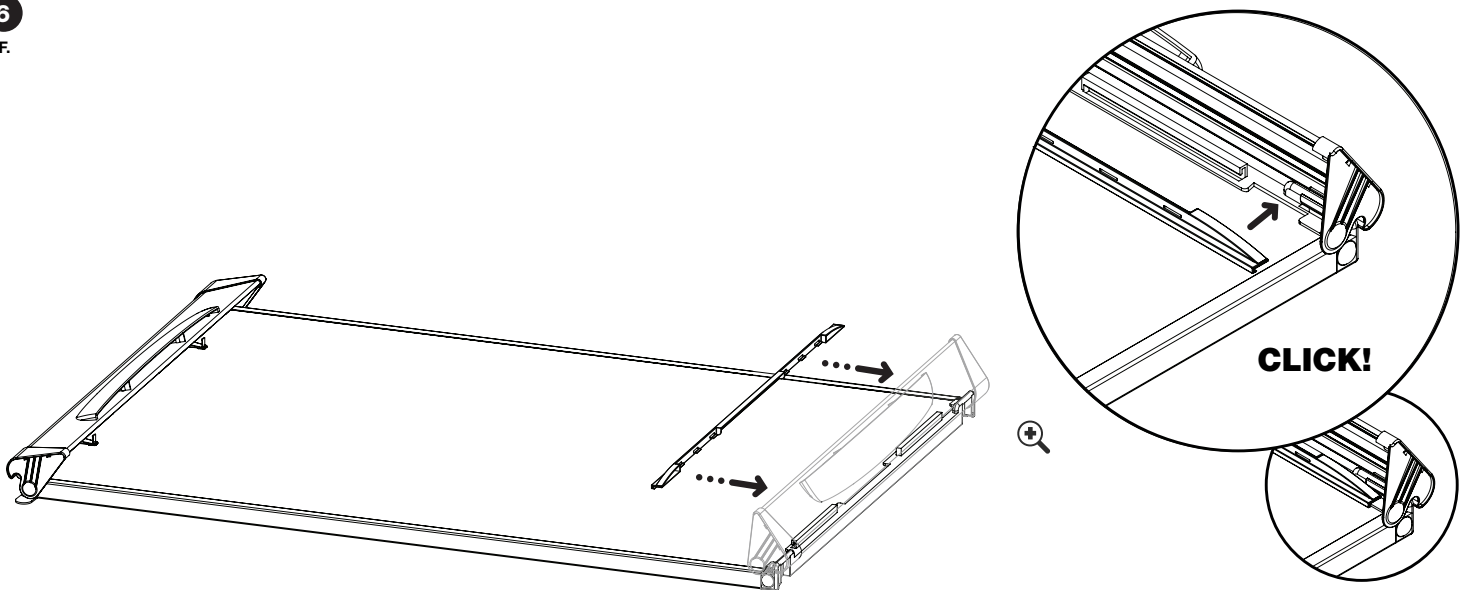

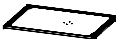







2x.D.
1x.E.



6

1x.F.



- | | | | | | | | | | |
|---|--|--|--|--|--|--|--|--|--|
| A.1x
 | B.2x
WITH EXTENSIBLE ARMS
 | C.2x
 | D.4x
 | E.2x
 | F.1x
 | G.1x
 | H.4x
 | I.1x
 | J.1x
 |
| K.2x
 | L.1x
 | M.1x
 | N.1x
 | O.5x
 | P.1x
 | Q.1x
 | R.1x
 | | |

1001380290789_REV03



DESIGN MOBILE EASEL

INSTRUCTIONS • INSTRUCTIES • ISTRUZIONI • ANLEITUNG • INSTRUCCIONES • INSTRUÇÕES

7



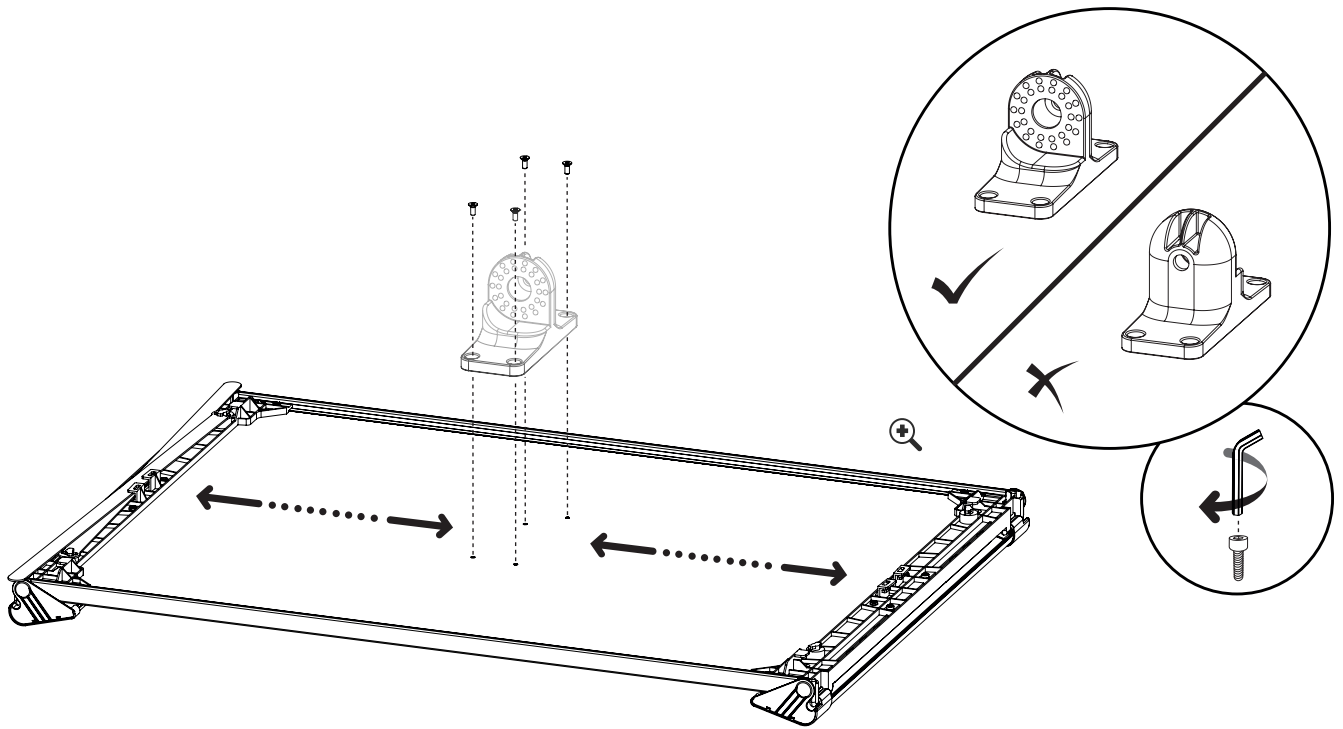





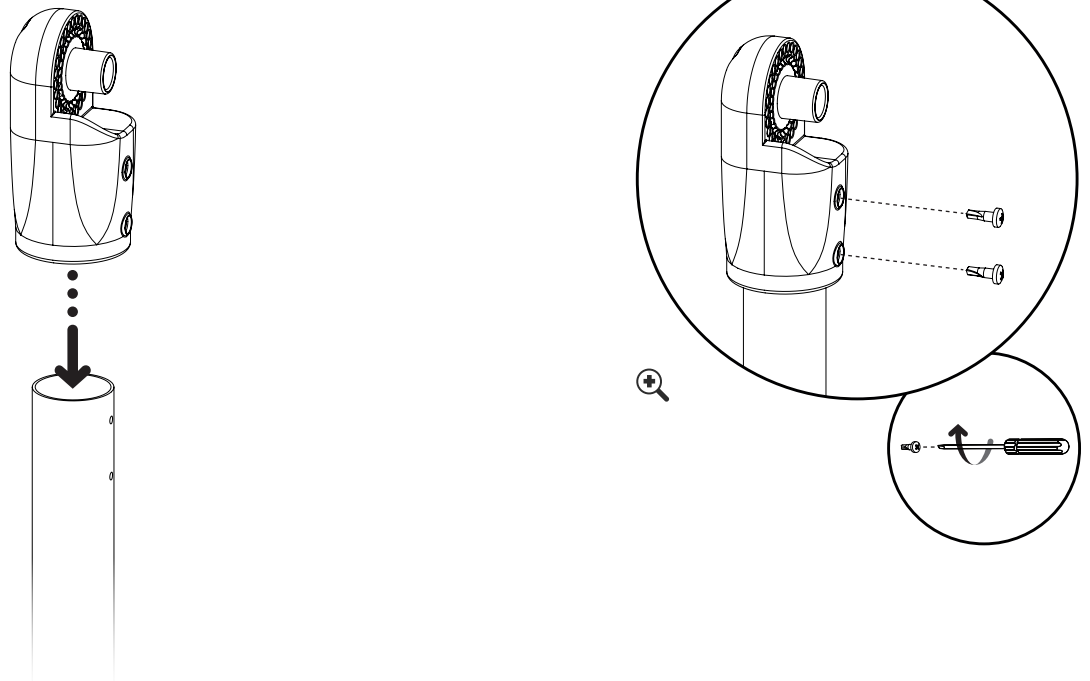

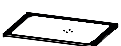







1x.G.
4x.H.
1x.R.



8

1x.I.
1x.J.
2x.K.



- | | | | | | | | | | | |
|---|--|--|--|--|--|--|--|--|--|--|
| A.1x
 | B.2x
WITH EXTENSIBLE ARMS
 | C.2x
 | D.4x
 | E.2x
 | F.1x
 | G.1x
 | H.4x
 | I.1x
 | J.1x
 | |
| K.2x
 | L.1x
 | M.1x
 | N.1x
 | O.5x
 | P.1x
 | Q.1x
 | R.1x
 | | | |

1001380290789_REV03



DESIGN MOBILE EASEL

INSTRUCTIONS • INSTRUCTIES • ISTRUZIONI • ANLEITUNG • INSTRUCCIONES • INSTRUÇÕES



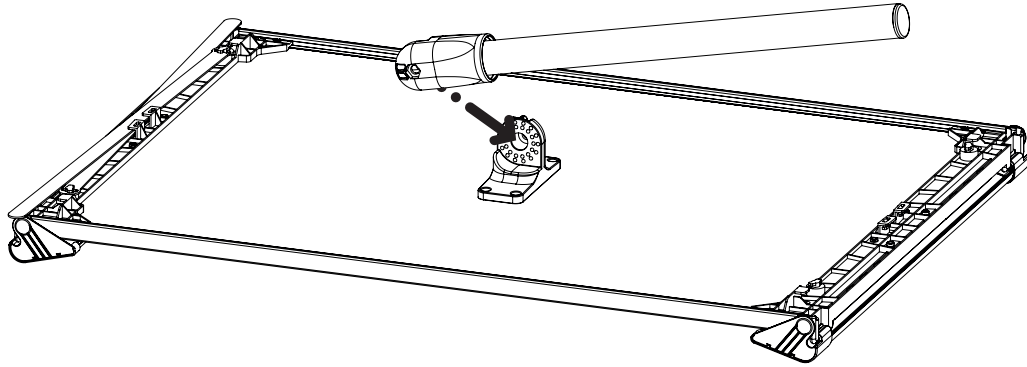





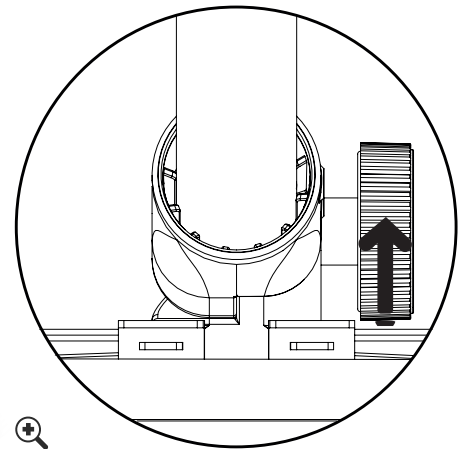
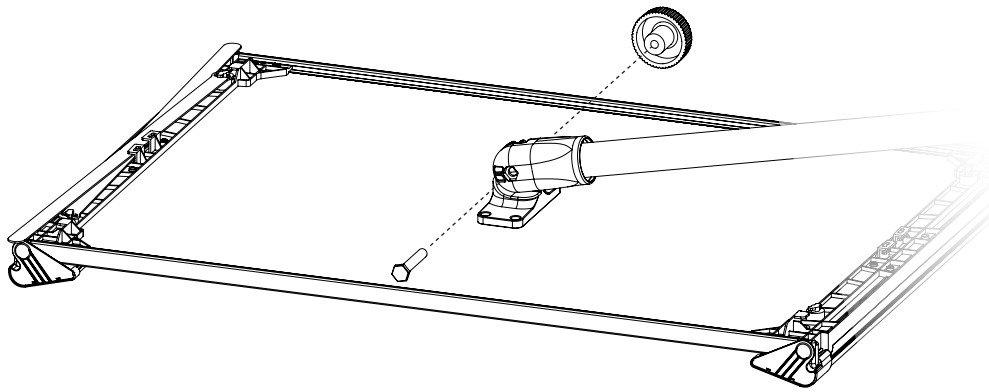

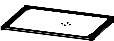







9



10

1x.L.
1x.M.



- | | | | | | | | | | |
|---|--|--|--|--|--|--|--|--|--|
| A.1x
 | B.2x
WITH EXTENSIBLE ARMS
 | C.2x
 | D.4x
 | E.2x
 | F.1x
 | G.1x
 | H.4x
 | I.1x
 | J.1x
 |
| K.2x
 | L.1x
 | M.1x
 | N.1x
 | O.5x
 | P.1x
 | Q.1x
 | R.1x
 | | |

1001380290789_REV03



DESIGN MOBILE EASEL

INSTRUCTIONS • INSTRUCTIES • ISTRUZIONI • ANLEITUNG • INSTRUCCIONES • INSTRUÇÕES

11

1x.N.
1x.P.

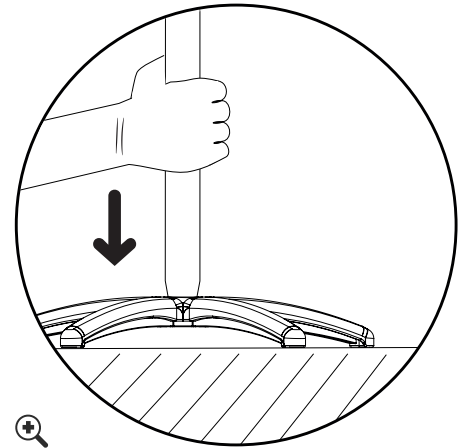
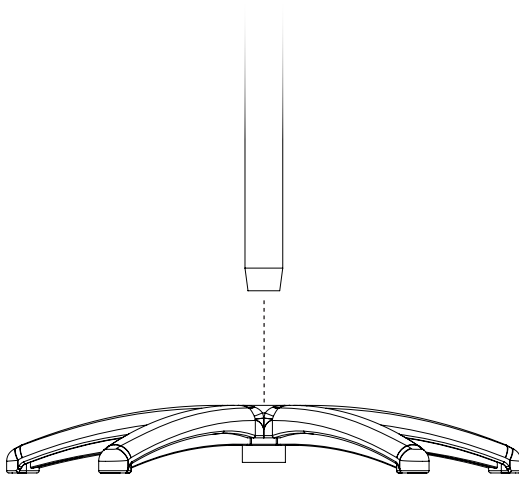







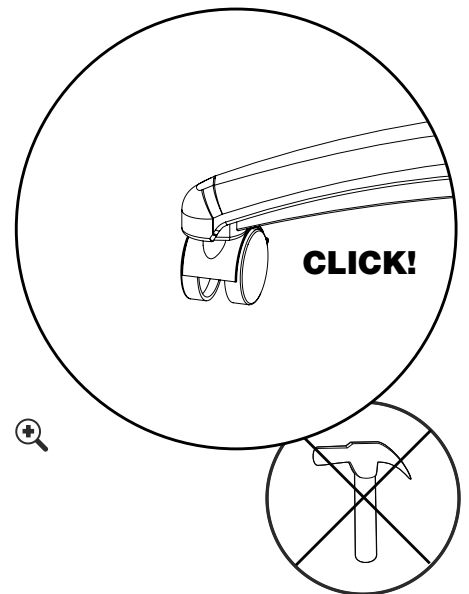
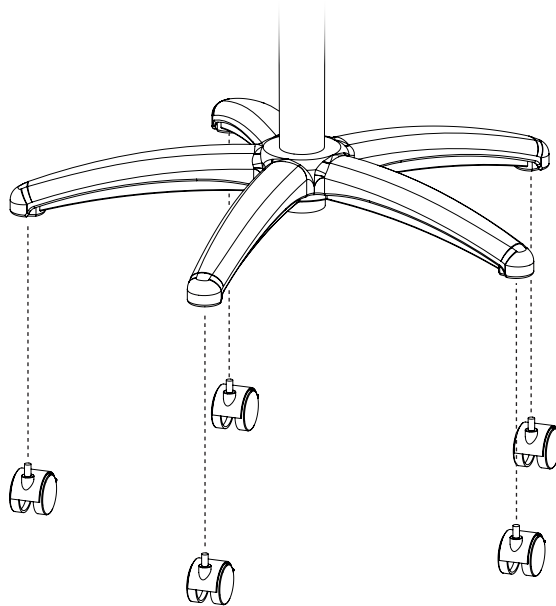

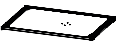









PRESS HARD AGAINST THE GROUND

12

5x.O.



- | | | | | | | | | | |
|---|--|--|--|--|--|--|--|--|--|
| A.1x
 | B.2x
WITH EXTENSIBLE ARMS
 | C.2x
 | D.4x
 | E.2x
 | F.1x
 | G.1x
 | H.4x
 | I.1x
 | J.1x
 |
| K.2x
 | L.1x
 | M.1x
 | N.1x
 | O.5x
 | P.1x
 | Q.1x
 | R.1x
 | | |

1001380290789_REV03



DESIGN MOBILE EASEL

INSTRUCTIONS • INSTRUCTIES • ISTRUZIONI • ANLEITUNG • INSTRUCCIONES • INSTRUÇÕES





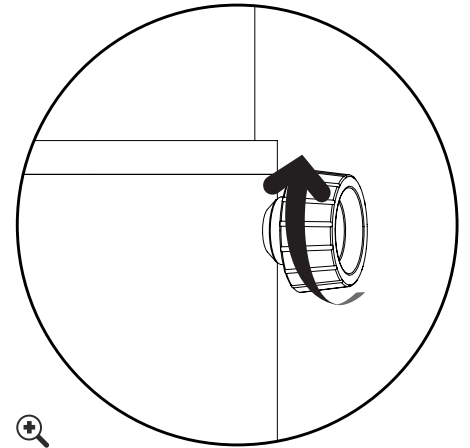
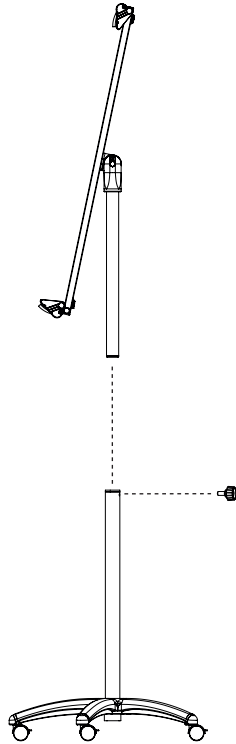



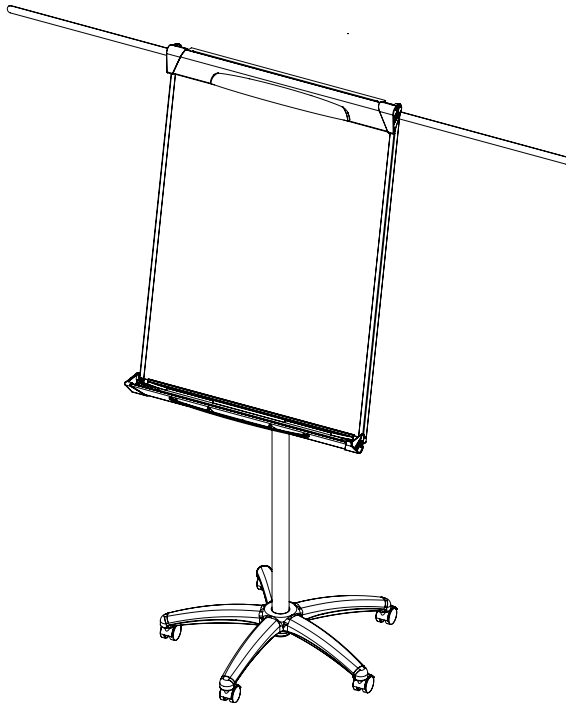

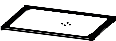







13

1x.Q.



14



- | | | | | | | | | | |
|---|--|--|--|--|--|--|--|--|--|
| A.1x
 | B.2x
WITH EXTENSIBLE ARMS
 | C.2x
 | D.4x
 | E.2x
 | F.1x
 | G.1x
 | H.4x
 | I.1x
 | J.1x
 |
| K.2x
 | L.1x
 | M.1x
 | N.1x
 | O.5x
 | P.1x
 | Q.1x
 | R.1x
 | | |

1001380290789_REV03

